

MaxiDalle

FORMWORK



PRODUCTIVITY | QUALITY | SAFETY | ERGONOMICS

THE EXTRA-LARGE
FORMWORK PANEL



Alphi
Formwork and solutions

MaxiDalle | The extra-large formwork panel



MaxiDalle

The MaxiDalle range is a panel-type formwork system for **large cells**.

The high-performance system is capable of supporting a concrete slab of up to 50 cm in thickness.

Simple: MaxiDalle comprises a single prop head for all assembly configurations and a formwork panel that comes in four sizes.

A snap-on joint provides **complete sealing** of the formwork.

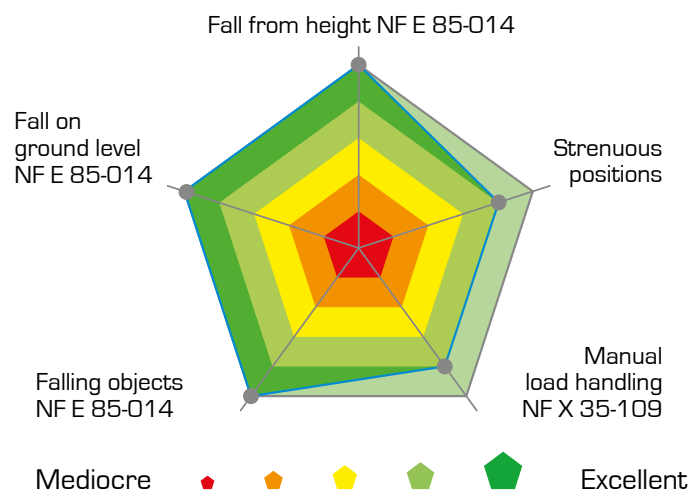

SAFETY AND ARDUOUSNESS PERFORMANCE CHARACTERISTICS

MaxiDalle is the best-performing panel formwork of its generation in terms of the constraints of the NF E 85-014 and NF X 35-109 standards.

Site:
La Cartoucherie
car park
Client: Eiffage
Location: Toulouse

MaxiDalle | The extra-large formwork panel



PRODUCTIVITY

- High installation work rate.
- Flexible use thanks to the various solutions for handling compensations (sheet, batten, H2O beam support).
- A single head for all configurations.
- Joint can be reused up to 5 times.
- Ergonomic panel handling tool: MaxUpDown.

QUALITY

- The insertion of the formwork panels combined with the snap-on joint creates a quality facing.
- The flashing left by the joint is admired for its clean and neat appearance.
- The joint seals the panel and enables the use of self-levelling concrete.



SAFETY

- Ground-based fitting and removal of panels and compensations when greater than 20 cm.
- The full surface inherent to the system forms a proper working platform.
- The AlphiSafe collective safety system is integrated in the panel using suitable adapters. It helps limit falls from height.



ERGONOMICS

- Lightweight panels: 28 kg for the 120 x 150 cm panel. 2 workers are sufficient for handling, in compliance with labour regulations.
- At extra-high heights, the MaxUp-Down tool enables easier panel handling and helps reduce repetitive strain injuries.



MAXUPDOWN
HELPS INCREASE
THE WORK RATE TO
40 M² /PERSON/DAY



WITHOUT MAXUPDOWN

Surface area: 120 m²
Height: 3.90 m
4 workers
30 m²/person/day



Productivity +25%



WITH MAXUPDOWN

Surface area: 120 m²
Height: 3.90 m
3 workers
40 m²/person/day





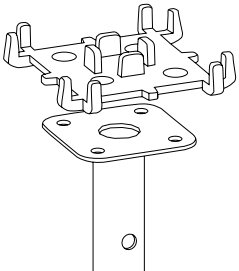

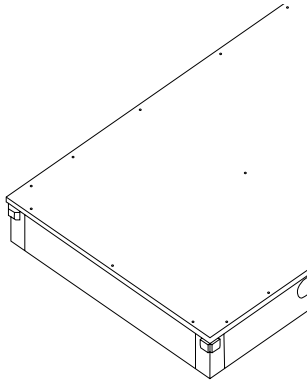
3 SIMPLE COMPONENTS

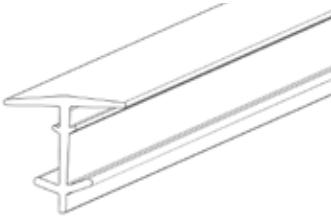
1	Head (prop + plate)	Description
		<ul style="list-style-type: none"> Prop with 120 x 120 mm plate, bore holes spaced at 80 mm MaxiDalle plate: a single model for all assembly configurations



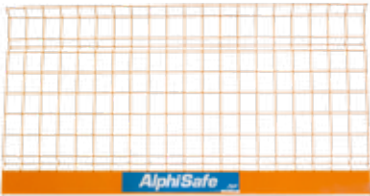

2	Formwork panel	Name	Dimensions W x L x H (cm)	Unit weight (kg)	Description
		MaxiDalle 30	30 x 150 x 14	9.00	<ul style="list-style-type: none"> 4 panel sizes Possible compensation system
		MaxiDalle 60	60 x 150 x 14	14.00	
		MaxiDalle 90	90 x 150 x 14	19.00	
		MaxiDalle 120	120 x 150 x 14	28.00	

3	Joint	Width (mm)	Thickness (mm)	Description
		20	2	<ul style="list-style-type: none"> Snap-on for quick assembly Reliable hold during all phases of formwork and casting Reusable (number of reuses: 5)

MAXIDALLE ACCESSORIES

Safety	Mesh*	Dimensions w x h (m)	Weight (kg)	Description
		1.25 x 1.30	7.60	<ul style="list-style-type: none"> The wire mesh is galvanized, with polyester powder coating
		2.40 x 1.30	13.90	
		2.50 x 1.30	14.50	
	Galvanized post*	Cross-section (cm ²)	Height (m)	Weight (kg)
	3.5 x 3.5	1.34	3.50	
Alphi formwork adapter*	Name	Weight (kg)	*Compliant with EN 13374 standard	
	MaxiDalle adapter	3.60		
Leborgne tools	Nanovib® range	Description		
		<ul style="list-style-type: none"> Tools suitable for fitting and removing Alphi formwork: hammers, hammer holder, prop key Vibration and noise reduction  <p>Click here to view details of Leborgne Tools</p>		





MAXIDALLE ACCESSORIES

Additional	Gauge stick	Length retracted / deployed (m)	Unit weight (kg)	Description
		1.80 / 2.90	2.00	<ul style="list-style-type: none"> Use up to 3.50 m
	Formwork removal pole	Length (m)	Unit weight (kg)	
		3.20	7.00	
	Compensation support	Unit weight (kg)	Description	
		2.30	<ul style="list-style-type: none"> Support for H20 beam and 18 mm plywood 	
	Compensation plate	Dimensions W x L (cm)	Thickness (mm)	
		30 x 150	2	
	50 x 150	2		
Compensation batten (to receive 15 mm plywood)	Dimensions h x L (cm)	Thickness (cm)		
	12.50 x 139	4		

Handling	MaxUp	Dimensions W x L x h [cm]	Maximum working height (m)	Unit weight including cylinder (kg)
		70 x 125 x 170	4.20	74.00
MaxDown	Dimensions W x L x h [cm]	Maximum working height (m)	Unit weight including cylinder (kg)	
	130 x 160 x 230	4.20	96.00	

MAXIDALLE ACCESSORIES

Boundary barrier	Bracket	Dimensions L x h (m)	
		0.54 x 1.08	
	Ballast	Unit weight (kg)	
		25.00	
	Tube	Length (m)	Diameter (mm)
		3.00	33.4
Assembled unit	Description		
	<ul style="list-style-type: none"> Barrier + ballast + tube 		

Stabilisation	150 cm frame 120 cm cross-member	Weight (kg)	
		38.60	
	Skin clamp	Unit weight (kg)	Description
		3.00	<ul style="list-style-type: none"> Stabilising clamp for use with 48 mm tube and collars
	Girder clamp	Unit weight (kg)	Description
		3.00	<ul style="list-style-type: none"> The tube is inserted into the prop used for cladding
Prop clamp	Unit weight (kg)	Description	
	5.00	<ul style="list-style-type: none"> The 45°-oriented rear plate allows retrospective fastening with the prop 	

ALPHISAFE COLLECTIVE PROTECTION

AlphiSafe is a collective protection system for formwork and slab edges. The technical innovations in the system allow **safe installation** and **automatic locking**.

Robust AlphiSafe is certified by Ginger CEBTP, as per the **EN 13374 standard of July 2013**, as class A and B for some components.

AlphiSafe is distinguished by its **height of 1.30 m**, which is above the minimum height of 1.00 m set by the standard, and protects traditional slab formwork up to 30 cm thick.



The mesh is locked at the top by the anti-lifting pin and locked in rotation at the base.

Installation of AlphiSafe safety system in cantilever configuration from bottom



USER GUIDE

STABILISATION

- MaxiDalle must be stabilised at cell commencement and during cell installation.
- For cells greater than 100 m² in size or on commencing, intermediate stabilisations should be added, every 100 m², using cross-member frames or clamps.
- 3 stabilisation solutions can be used at commencement.

Cross-member frame

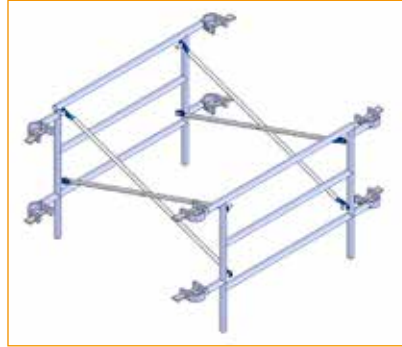

- Cross-member frame system.



- A cross-member frame is fitted provisionally on the first 4 props.

Skin clamp



- Skin clamp + tube system.



- Set up the stabilisation of the first components.
- Once in place, the tripods can be removed.

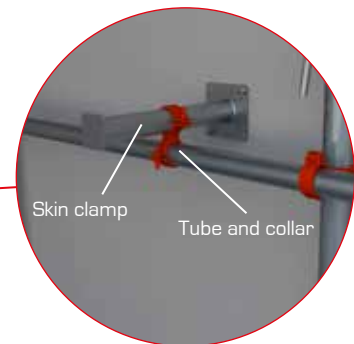

Girder clamp



- Girder clamp + tube system.



- Set up the stabilisation of the first components.
- Once in place, the tripods can be removed.

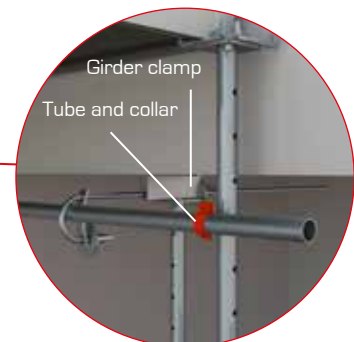

MAXIDALLE INSTALLATION WITH TRIPODS



Panel installation should start on the side of the arrow indicated in the installation drawing.
- Install 4 props equipped with MaxiDalle tie plates, using tripods.
- Fit the first panel flat using a rolling safety ladder.

- Attach the second panel vertically to the props.



- Using the gauge stick, the form fitter raises the panel safely, until it is in the horizontal position.

- Whilst keeping the panel resting on the gauge stick, the form fitter installs the props.

CONTINUED INSTALLATION WITH SKIN CLAMPS

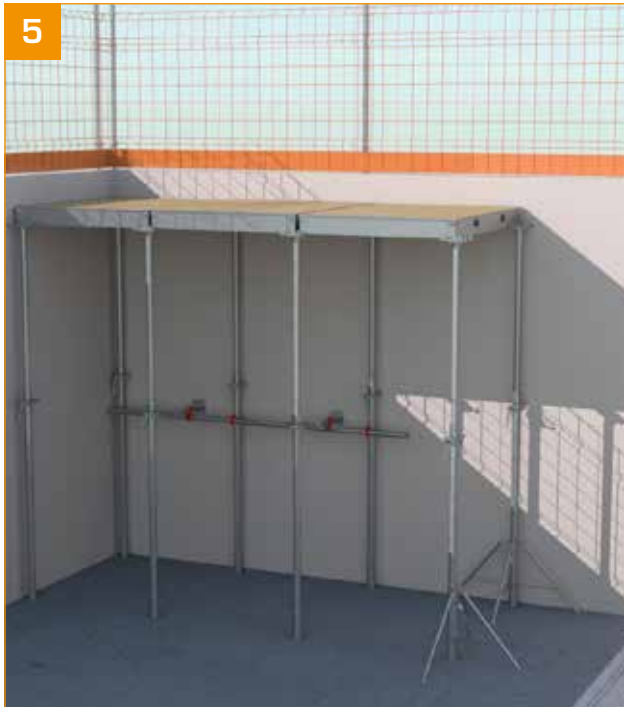

Stabilisation can be performed using skin clamps, prop clamps or cross-member frames.

- Fitting of skin clamps suitable for use for formwork stabilisation.



- Start the second frame by hanging the first panel.



- Raise the first panel using the gauge stick, and hold it in the horizontal position.
- Position the first prop of the second frame against the wall and complete the stabilisation with skin clamps.



- Raise the second panel using a second gauge stick and position the next prop
- Continue from one to the next.

MAXIDALLE INSTALLATION WITH TRIPODS



- The cell is formed and the slab is cast.

MAXIDALLE FORMWORK REMOVAL WITH ROLLING SAFETY LADDERS



If applicable, start formwork removal with a panel close to a compensation zone.

- The panel to be removed is held by 4 props
- Remove the props on the side of the free edge of the panel. The panel cannot fall as it is fixed onto the rear props.



- Position the rolling safety ladders on either side of the panel to be removed.
- Remove the final holding prop.



- Remove the rear props.
- Lower the panel to be removed.
- Continue from one to the next.

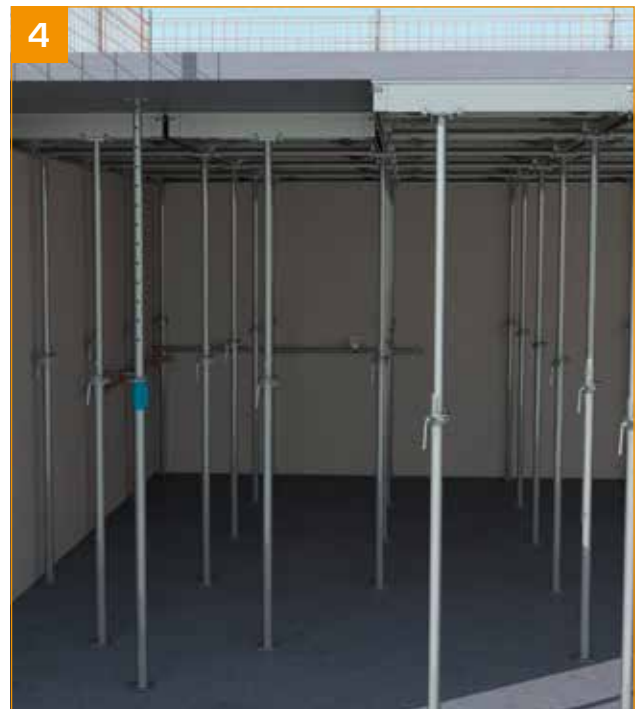

- If required, the slab may be shored underneath by drying props.

MAXUPDOWN FOR MAXIDALLE



MaxUP

MaxUp is a tool enabling MaxiDalle formwork panels to be fitted effortlessly onto prop heads.



MaxDown

MaxDown is a tool enabling easier MaxiDalle formwork panel removal at extra-high heights. Protective netting receives and secures the panel as it is lowered.

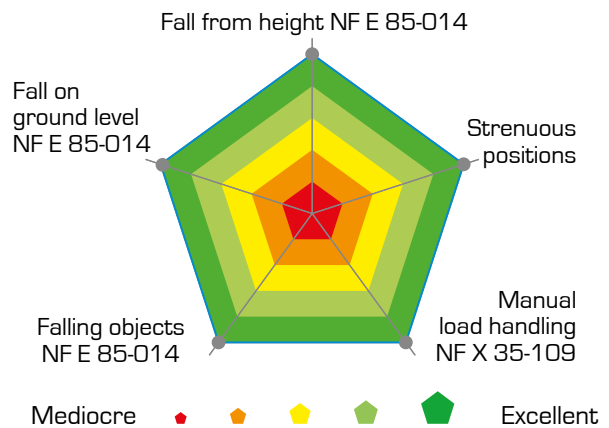

SAFETY AND ARDUOUSNESS PERFORMANCE CHARACTERISTICS

Fitters work at ground level (no need for rolling safety ladder). They no longer need to handle heavy loads at heights.

MAXUP USER GUIDE

MAXUP PREPARATION AND CHECK



- Move the MaxUp, without the compressed air cylinder, to the formwork zone with the crane.



- Fit a cylinder on the device, strap it and connect it to the pressure-reducing valve.

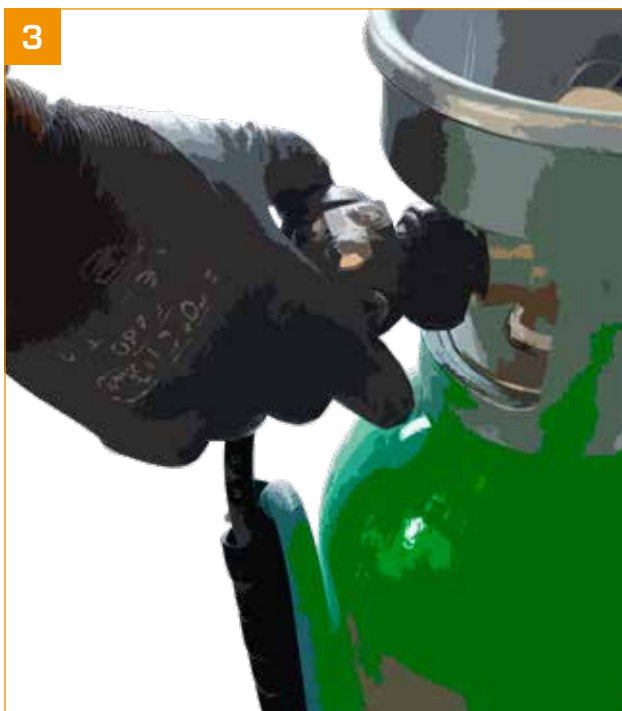

- Screw in by hand. **Do not use any tools.**



- Check the device according to the operator's manual.

MAXUP USER GUIDE

FLAT INSTALLATION OF THE FIRST MAXIDALLE PANEL



1 - Open out the rear arm of the MaxUp and lock it.



2 - Take a panel from the rack.



3 - The first panel is placed flat and centred on the head of the device.



4 - The 2 central profiles of the panel support the buffers.



- Move the device to the desired location to start the formwork.

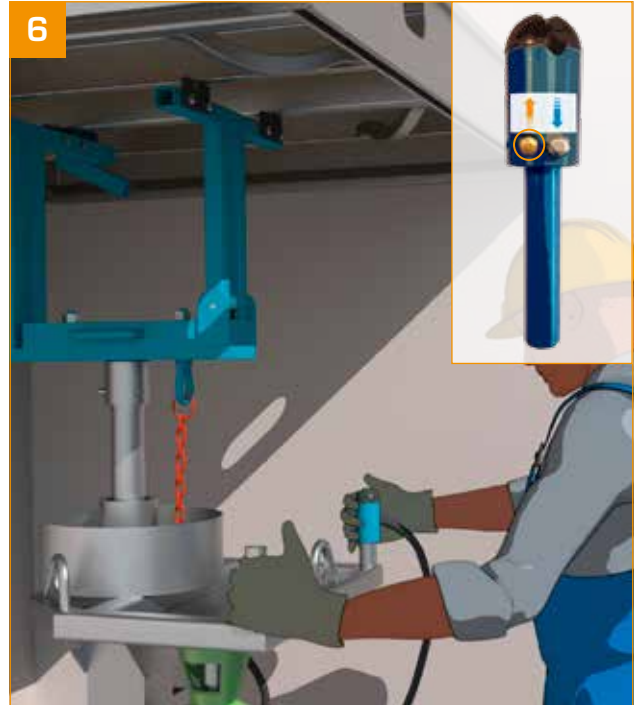

- Press the  up button on the control to position the panel at the desired height.



- Place the 4 props with their tripod at the 4 corners of the panel.

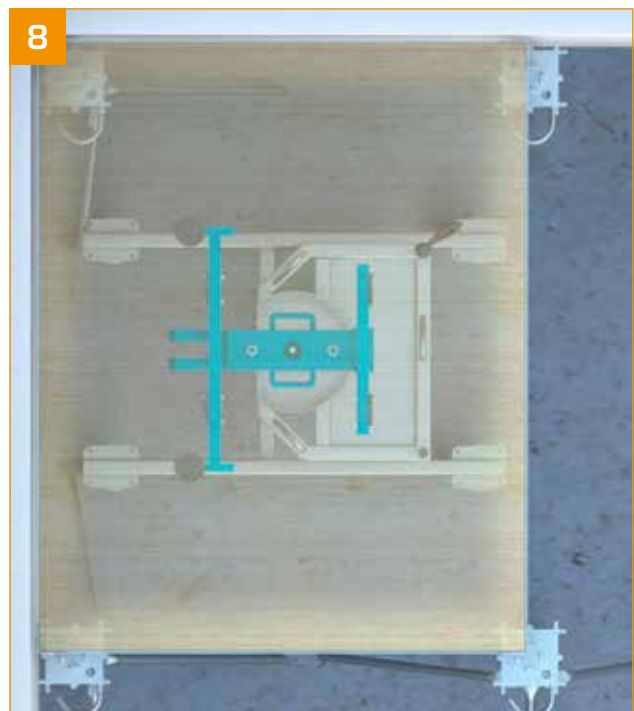

- The positioning of the MaxiDalle heads must be adapted to each assembly configuration.
- 3 possible configurations: in a wall corner / against a wall / in the standard position.

MAXUP USER GUIDE



- Lower the MaxUp using the  (1) button, followed by the quick-release lowering lever (2) on the control.



- Go to the next panel [vertical hook], folding up the rear support.

INSTALLATION OF SUBSEQUENT PANELS FROM THE LONG SIDE



- After tilting the panel to the long side, hang it manually on the head of the device for vertical lifting.



- The panel profile is centred and comes into contact with the 2 cylindrical buffers.



- Position the MaxUp at the desired location, the operator is positioned under the panel fitted previously.



- Raise the panel to the desired height: **the top edge must be aligned with the top of the panel already in place.**



- Secure the chain with the spring hook to maintain the desired height when installing the subsequent panels.

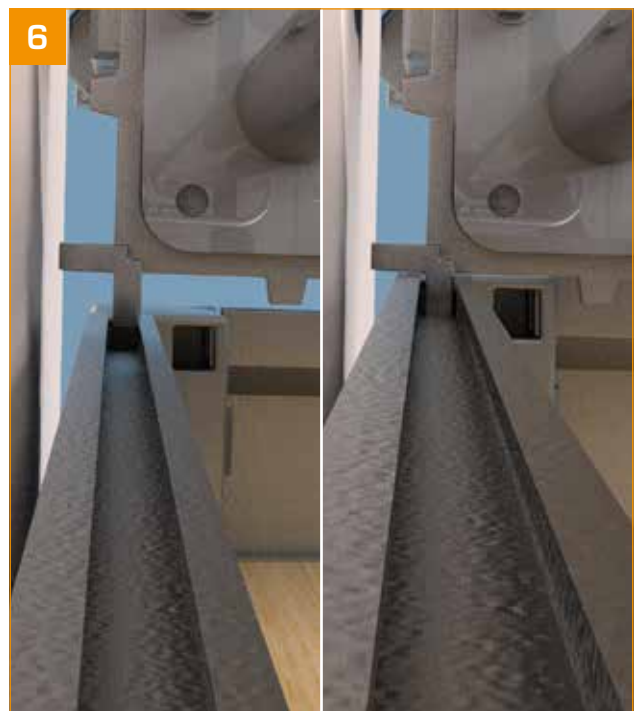

- Move the MaxUp so that the head hook is inserted into the profile on the skin side.

MAXUP USER GUIDE

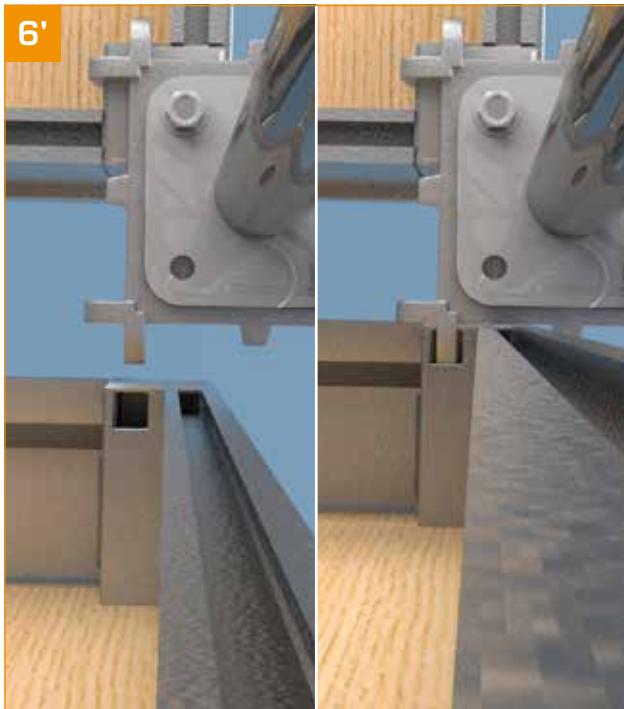

6' - Move the MaxUp so that the head hook is inserted into the empty side profile.



7 - Lower the panel slowly using the  button.
- Make sure that the head hooks are inserted into the 2 corners of the panel.

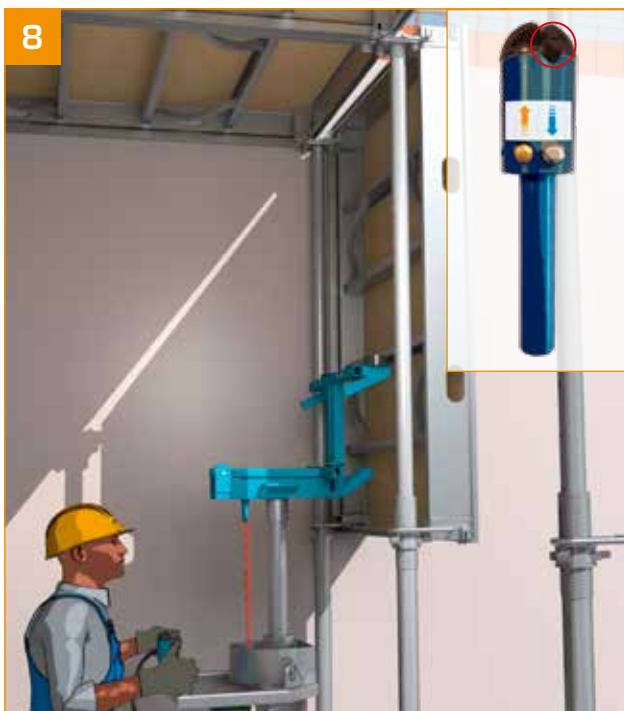

8 - When the panel is properly attached, lower the head by actuating the quick-release lowering lever.



9 - Remove the MaxUp from under the formwork in order to tilt the panel using the MaxiDalle pole, previously adjusted to the correct height.

10



- Position the final 2 props under the panel.

11

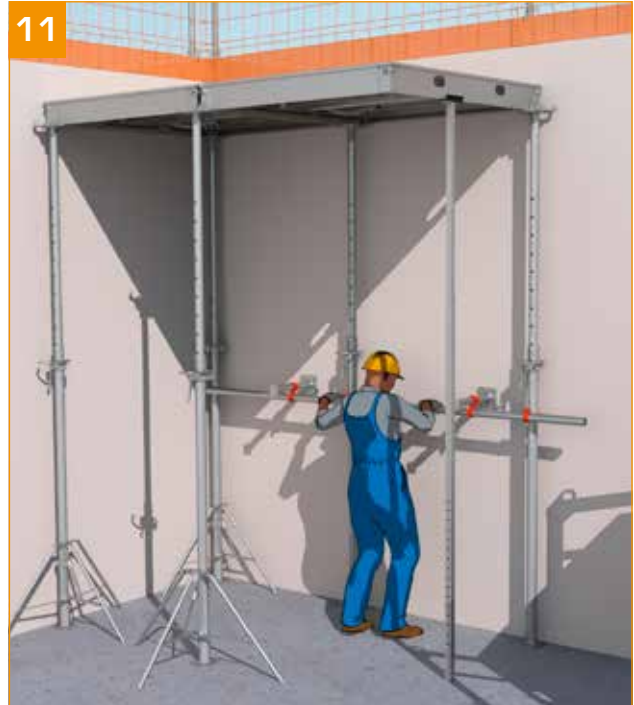

- Set up the final stabilisation of the formwork.
- Continue to lay the formwork from one to the next up to the skin.

INSTALLATION OF SUBSEQUENT PANELS FROM THE SHORT SIDE

1



- Retrieve the panel from the rack using the MaxUp and raise it 20 cm to make it easier to move.

2



- Move the MaxUp to continue the formwork phase.

MAXUP USER GUIDE



- Mount the panel until the chain comes to a stop.
- Position it above the MaxiDalle heads.



- Lower the panel slowly using the  button.
- Make sure that the head hooks are inserted into the 2 corners of the panel.



- When the panel is properly attached, lower the head by actuating the quick-release lowering lever.



- Remove the MaxUp from under the formwork in order to tilt the panel using the MaxiDalle pole, previously adjusted to the correct height.
- Repeat the operation from one to the next as required.

MAXDOWN USER GUIDE

MAXDOWN PREPARATION AND CHECK



1 - Move the MaxDown, without the compressed air cylinder, to the formwork zone with the crane.



2 - Fit a cylinder on the device, strap it and connect it to the pressure reducing valve.

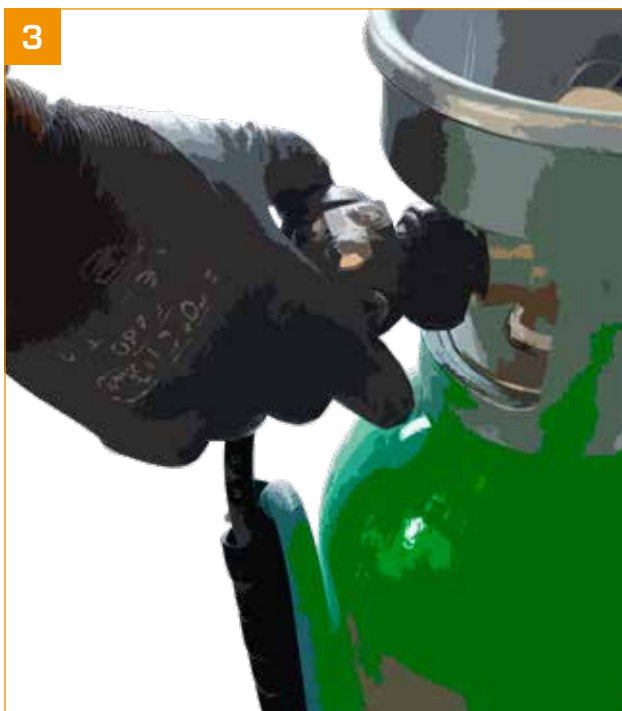

3 - Screw in by hand. **Do not use any tools.**



4 - Check the device according to the operator's manual.

MAXDOWN USER GUIDE

USING MAXDOWN



- Place the MaxDown under the first MaxiDalle panel to be removed
- Make sure that the device is positioned correctly before lowering the panel.



- Raise the MaxDown drop head in contact with the panel using the  button.



- Remove a first prop.



- Then remove the other props supporting the panel to be removed.
- Secure the next panel using a prop.



- Remove the panel using the formwork removal pole.
- Make sure that the panel is resting on the netting

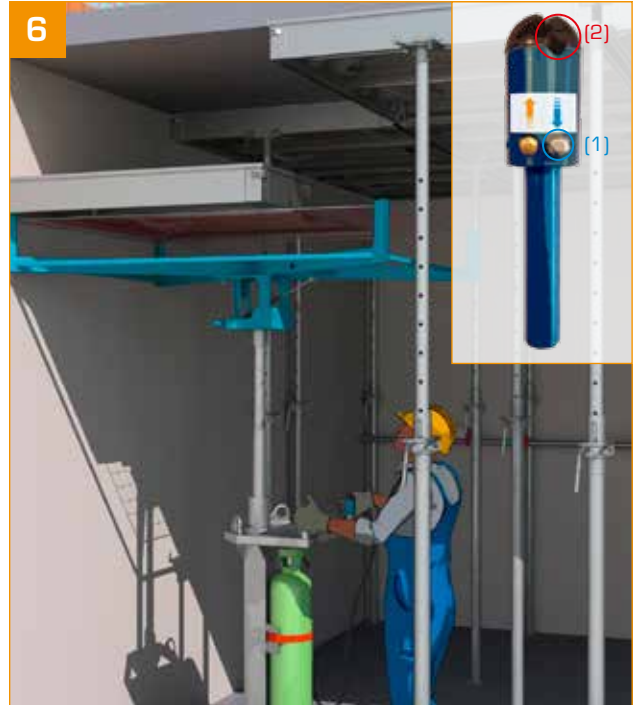

- Lower the MaxDown using the  (1) button, followed by the quick-release lowering lever (2) on the control



- Tilt the panel by unlocking the MaxDown head.



- Retrieve the panel and store it in the MaxiDalle rack.
- Repeat the operation from one to the next as required.

BOUNDARY BARRIERS

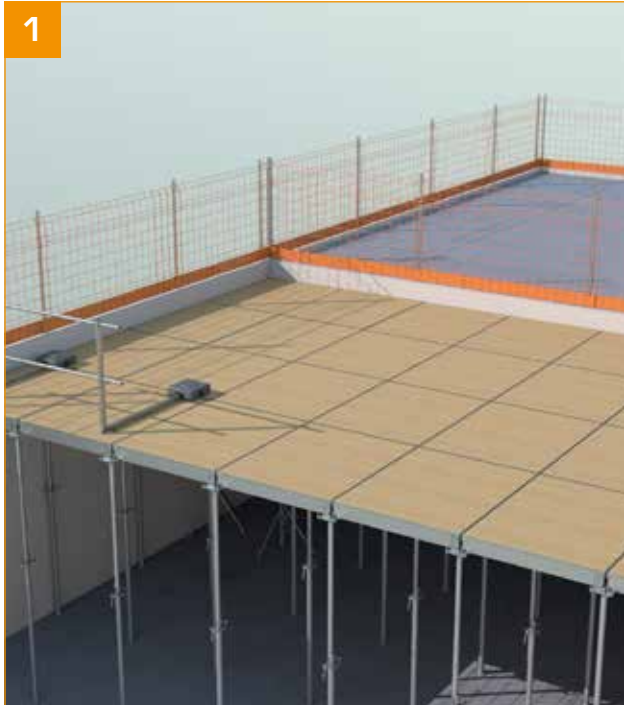

These barriers are used to define a work area for workers working after the formwork phase.

- From ground level, fit the boundary barriers using 2 rolling safety ladders.
- This stage is performed at a rate of 2 workers per 3 m block containing 2 bases.

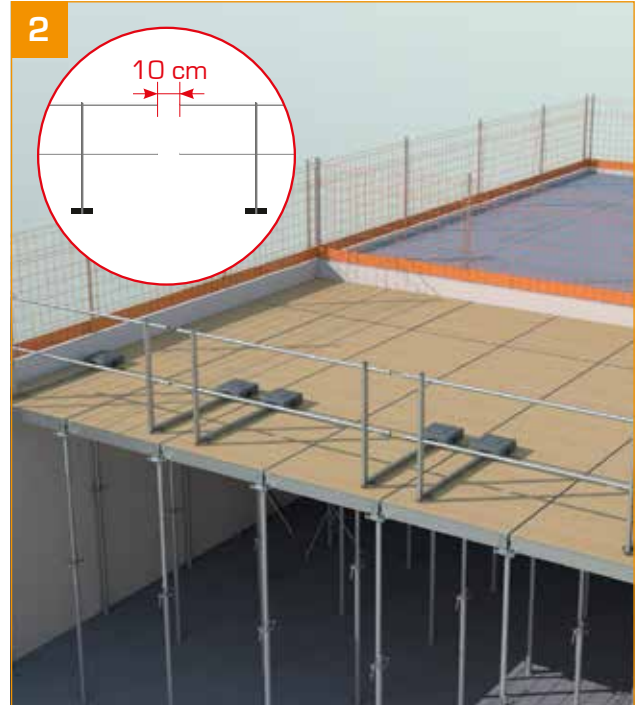

- Before working in the area within the boundary, the formwork must be continued for 3 m beyond the boundary barriers.

Caution: maximum gap between 2 barriers of 10 cm.

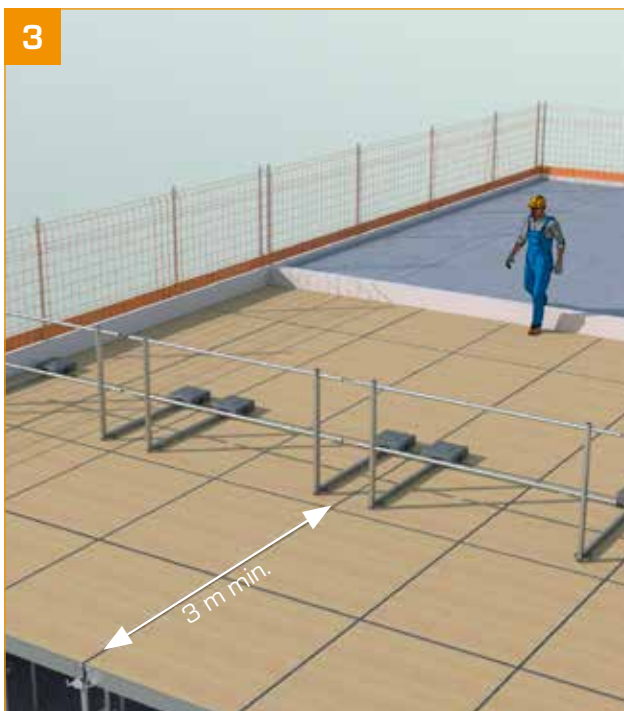

- Complete the formwork of the cell with boundary barriers over at least 3 m, before any work in the area within the boundary.



- The area within the boundary is then accessible.
- All work before casting the slab will be performed in this area.

COMPENSATION MANAGEMENT

With compensation plate

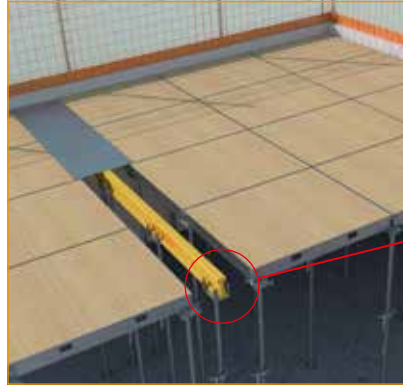
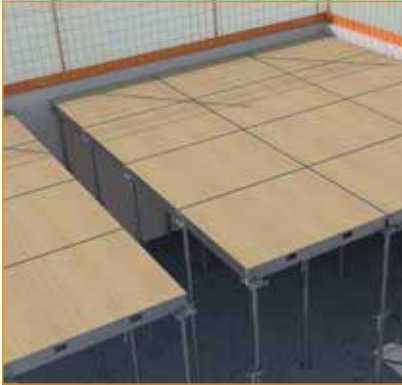

- Minimise the gap by combining panels of different sizes.
- Up to a gap of 19 cm, no risk of falls from height.

- Fit the plate over the gap.
- Nail the plate onto the MaxiDalle plywood.
- Between 20 and 30 cm, add a beam.
- The gap is thus less than 30 cm.

With compensation support

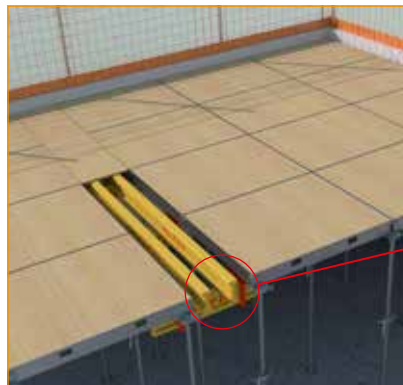

- Minimise the gap by combining panels of different sizes.

- Fix the compensation supports into the grooves of the MaxiDalle.
- Cut the 18 mm plywood to seal the gap.

With compensation batten

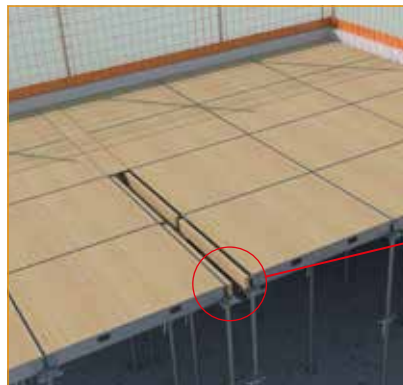
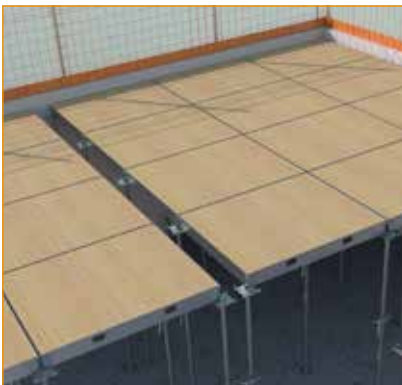

- Minimise the gap by combining panels of different sizes.
- The gap is thus less than 30 cm.

- Position the compensation battens directly on the MaxiDalle heads.
- Position the plywood.

ALPHI, THE LEADING FRENCH MANUFACTURER OF SLAB FORMWORK



MaxiDalle is panel type formwork designed for large cells, making it the ideal system for commercial building construction. The use of the panels at extra-high heights is facilitated by the ingenious MaxUpDown tool, designed to make work less arduous.

Savoie Hexapole, Actipole 5 - Rue Maurice Herzog
73420 Viviers-du-Lac
FRANCE

Tel. +33 (0)4 79 61 85 90 - Fax +33 (0)4 79 61 85 99 - info@alphi.fr

Design Office: Tel. +33 (0)4 79 61 85 91 - be@alphi.fr

Logistics Department: Tel. +33 (0)4 79 61 85 92

Alphi
Formwork and solutions

Designed in France 

www.alphi.fr